

FOG

Caratteristiche Tecniche

IEC 80 - 90

Technical Characteristics

Pump Pompa	Pressure Pressione		Volume Portata				RPM giri/min		Power Potenza			
			l/min		GPM				HP		kW	
	bar	PSI	50 Hz	60 Hz	50 Hz	60 Hz	50 Hz	60 Hz	50 Hz	60 Hz	50 Hz	60 Hz
FOG0110CR	100	1450	1.0	1.2	0.2	0.3	1450	1740	0.3	0.4	0.2	0.3
FOG0210CR	100	1450	2.0	2.4	0.5	0.6	1450	1740	0.5	0.6	0.4	0.5
FOG0410CR	100	1450	4.0	4.8	1.0	1.2	1450	1740	1.0	1.2	0.8	1.0
FOG0610CR	100	1450	6.0	7.2	1.6	1.9	1450	1740	1.5	1.8	1.1	1.3
FOG0810CR	100	1450	8.0	9.6	2.1	2.5	1450	1740	2.0	2.4	1.5	1.8

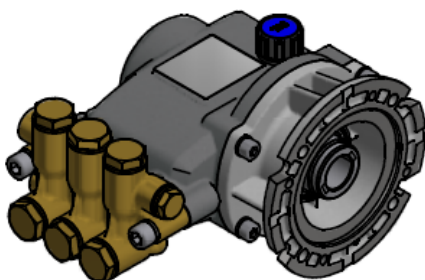

Dimensioni d'ingombro

Overall dimensions

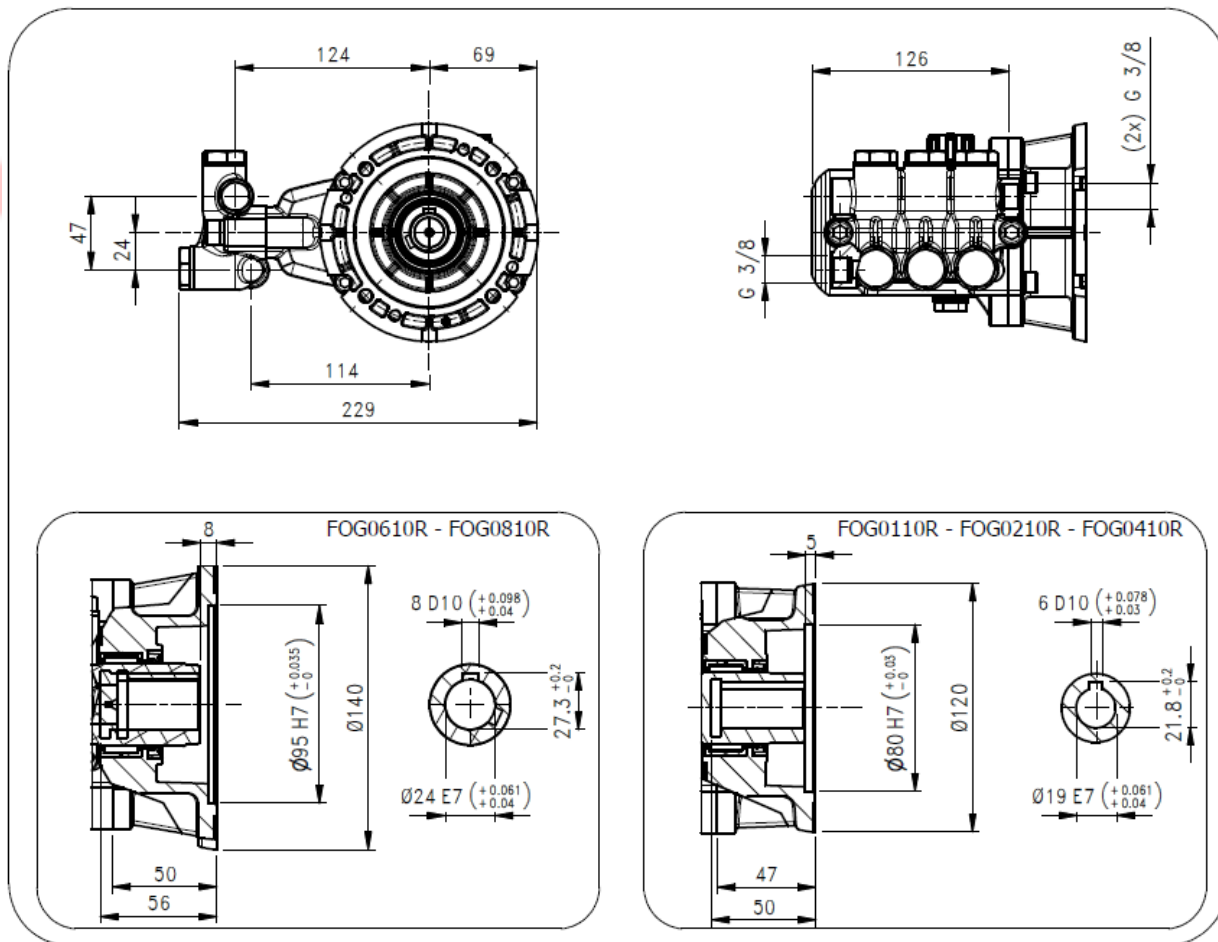

Lubrificazione: Olio SAE 10W40

Capacità: 0.25 Litri

Peso pompa: 5.6 kg

Lubrication: SAE 10W40 Oil

Capacity: 0.25 Litres

Weight: 5.6 kg

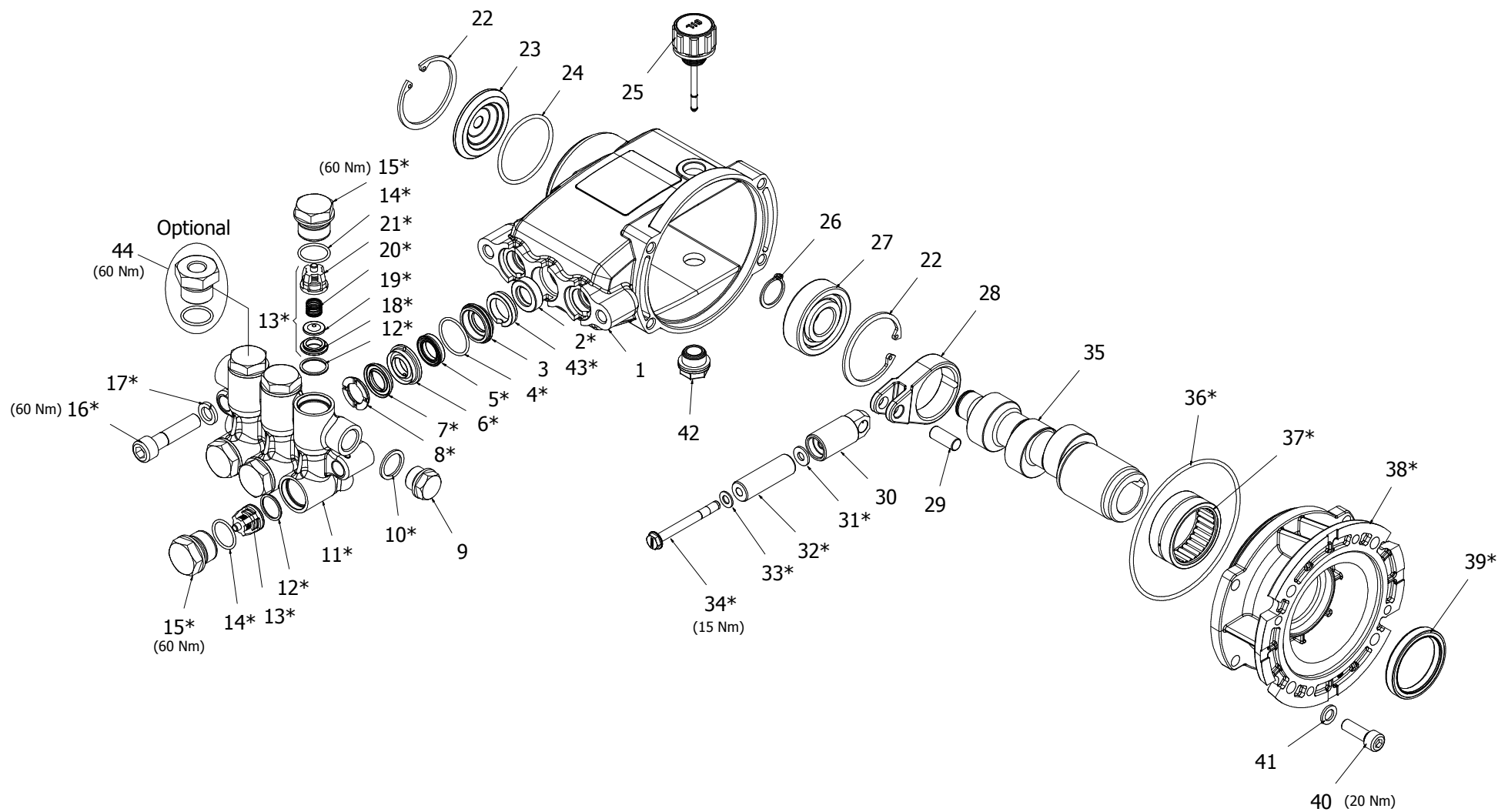

Rev. 8 03-2018

HAWK
SERIE FOG
FOG SERIES

FOG 2014 SERIES

ORDINARY MAINTENANCE KIT / KIT MANUTENZIONE ORDINARIA

KIT	Item Pos.	Part Number Codice	Description	Descrizione	Q.TY by Pump Q.TA per Pompa	FOG0110C	FOG0210C	FOG0410C	FOG0610C	FOG0810C
A	3x (3- 4- 5- 6- 7- 8)	1.905-618.0	COMPLETE SEAL PACKING	GUARNIZIONI PISTONE	1					
B	12- 13 (18- 19- 20- 21) 14	1.905-617.0	COMPLETE VALVE	VALVOLA COMPLETA	1	•	•	•	•	•

EXTRAORDINARY MAINTENANCE KIT / KIT MANUTENZIONE STRAORDINARIA

KIT	Item Pos.	Part Number Codice	Description	Descrizione	Q.TY by Pump Q.TA per Pompa	FOG0110C	FOG0210C	FOG0410C	FOG0610C	FOG0810C
C	31- 32- 33- 34	1.099-840.0	PLUNGER	PISTONE	3					
D	2 - 43	1.099-841.0	PLUNGER OIL SEALS	ANELLI TENUTA OLIO ASTA	1	•	•	•	•	•
E	36- 37- 38- 39	1.904-461.0	FLANGE KIT	KIT FLANGIA	1	•	•	•		
		1.904-462.0	FLANGE KIT	KIT FLANGIA	1				•	•
F	3- 4- 5- 6- 7- 8- 9- 10- 11- 12 13 (18- 19- 20- 21) 14- 15	1.099-842.0	COMPLETE MANIFOLD	TESTATA COMPLETA	1					
G	14- 15	1.904-249.0	VALVE PLUG ASSY	PREMONTATO TAPPO VAM	6	•	•	•	•	•

“Q.TY by Pump” => Necessary quantity to repair one pump
“Q.TA’ per Pompa” => Quantità necessaria per riparare una pompa

OPTIONAL

Item Pos.	Part Number Codice	Description	Descrizione	Q.TY by Pump Q.TÀ per Pompa	FOG0110C	FOG0210C	FOG0410C	FOG0610C	FOG0810C
44	9.853-424.0	THREADED BRASS PLUG G1/4	PREMONTATO TAPPO FORATO	1	•	•	•	•	•

TOOL KIT

Part Number Codice	Description	Descrizione	Q.TY by Pump Q.TÀ per Pompa	FOG0110C	FOG0210C	FOG0410C	FOG0610C	FOG0810C
9.853-525.0	TOOL-KIT	TOOL-KIT	1	•	•	•	•	•

IMPORTANT

IMPORTANTE

* **Part available ONLY in kit**
Disponibile SOLO in kit

(...) **Parts pre-assembled**
Parti pre-assemblate

PARTS LIST LISTA PARTI

Item Pos	Part Number Codice	Description	Descrizione	KIT	Q.TY Q.TÀ	FOG0110C	FOG0210C	FOG0410C	FOG0610C	FOG0810C
1	9.850-371.0	CRANKCASE	CARTER		1					
2*		PLUNGER OIL SEAL Ø15X24X5	ANELLO Ø15X24X5	D	3					
3*		PRESSURE RING	PRESSORE	A-F	3					
4*		OR 2100 1,78X25,12	OR 2100 1,78X25,12	A-F	3					
5*		LOW PRESSURE SEAL	ANELLO TENUTA BASSA PRESSIONE	A-F	3					
6*		INTERMED. RING	DIFFUSORE INTERMEDIO	A-F	3					
7*		HIGH PRESSURE SEAL	ANELLO TENUTA ALTA PRESSIONE	A-F	3					
8*		SUPPORT RING	DIFFUSORE ANELLO "V"	A-F	3					
9*		BRASS PLUG G3/8	TAPPO G3/8	F	1					
10*		COPPER WASHER G3/8	GUARNIZIONE RAME G3/8	F	1					
11*		MANIFOLD HOUSING	TESTATA	F	1					
12*		OR 2062 - Ø1,78X15,60	OR 2062 - Ø1,78X15,60	B-F	6					
13*		VALVE ASSEMBLY	PREMONTATO VALVOLA	B-F	6					
14*		OR 2075 - Ø1,78X18.77	OR 2075 - Ø1,78X18.77	B-F-G	6					
15*		MANIFOLD PLUG	TAPPO TESTATA	F-G	6					
16	9.851-486.0	SCREW M10X45	VITE M10X45		2					
17	9.851-154.0	LOCK-WASHER	ROSETTA ELASTICA		2					
18*		VALVE SEAT	SEDE VALVOLA	B-F	6	•	•	•	•	•
19*		VALVE PLATE	PIATTELLO VALVOLA	B-F	6					
20*		VALVE PLATE	MOLLA VALVOLA	B-F	6					
21*		VALVE CAGE	GABBIA VALVOLA	B-F	6					
22	9.851-205.0	SEEGER Ø52 UNI 7437	SEEGER Ø52 UNI 7437		2					
23	9.850-812.0	SIGHT GLASS	INDICATORE DI LIVELLO		1					
24	9.850-704.0	OR 3187 52,54X47,3	OR 3187 52,54X47,3		1					
25	9.851-285.0	OIL DIP STICK	TAPPO SFIATO OLIO		1					
26	9.851-199.0	SEEGER Ø20 UNI7435	SEEGER Ø20 UNI7435		1					
27	9.850-461.0	BALL BEARING 6304-20X52X15	CUSCINETTO 6304-20X52X15		1					
28	9.850-313.0	CONNECTING ROD	BIELLA		3					
29	9.851-216.0	CONNECTING ROD PIN	SPINOTTO		3					
30	9.850-103.0	PLUNGER ROD	ASTA GUIDA PISTONE		3					
31*		COPPER SPACER	ROSETTA PISTONE	C	3					
32*		PLUNGER	PISTONE	C	3					
33*		COPPER SPACER	ROSETTA RAME	C	3					
34*		SCREW M6X60	VITE M6X60	C	3					
35	9.850-196.0	CRANKSHAFT Ø24	ALBERO CAVO Ø24		1					•
	9.850-197.0	CRANKSHAFT Ø24	ALBERO CAVO Ø24		1				•	
	9.850-205.0	CRANKSHAFT Ø19	ALBERO CAVO Ø19		1	•				
	9.850-218.0	CRANKSHAFT Ø19	ALBERO CAVO Ø19		1		•			
	9.850-219.0	CRANKSHAFT Ø19	ALBERO CAVO Ø19		1			•		

Item Pos	Part Number Codice	Description	Descrizione	KIT	Q.TY Q.TÀ	FOG010C	FOG020C	FOG040C	FOG060C	FOG080C
36*		OR 3400 101.27XØ2.62	OR 3400 101.27XØ2.62	E	1	•	•	•	•	•
37*		BEARING NK35/20	CUSCINETTO NK35/20	E	1	•	•	•		
		BEARING NK40/20	CUSCINETTO NK40/20	E	1				•	•
38*		FLANGE B14 IEC80	FLANGIA B14 IEC80	E	1	•	•	•		
		FLANGE B14 IEC90	FLANGIA B14 IEC90	E	1				•	•
39*		OIL SEAL 35X45X7	ANELLO TENUTA 35X45X7	E	1	•	•	•		
		OIL SEAL 40X52X7	ANELLO TENUTA 40X52X7	E	1				•	•
40	9.851-468.0	SCREW M8X25 UNI 5931	VITE M8X25 UNI 5931		4					
41	9.851-152.0	LOCK-WASHER	ROSETTA M8 UNI 6592V		4					
42	9.851-301.0	CRANKCASE PLUG	TAPPO CHIUSURA CARTER		1	•	•	•	•	•
43*		PLUNGER OIL SEAL SPACER	DISTANZIALE CORTECO FOG	A-F	3					